



spring | summer
2019

Knirps



5 Jahre Garantie
auf jedes Schirmmodell

5 years warranty
for every umbrella

ZUVERLÄSSIGER SCHUTZ SEIT ÜBER 90 JAHREN.

Erfinden, entwickeln und weiterentwickeln ist das Credo von Knirps, der Marke, die 1928 die Welt revolutionierte. Vor mehr als 90 Jahren als bahnbrechende Erfindung gefeiert, ist die Marke Knirps heute mit einer breiten Produktpalette weltweit vertreten und ungebrochen erfolgreich. Konsequente Markenführung und innovative Produktentwicklung sind Garant für ausgefeilte Produkte mit gleichbleibend hoher Qualität, ausgereifter Funktionalität und zeitgemäßem Design. Unsere Inspiration beziehen wir aus den individuellen Bedürfnissen der Menschen. Daraus entstanden ist eine einzigartige Produktvielfalt, die vom Taschenschirm über den Stockschild bis zum Regenschirm mit UV-Schutz und von manuell über automatisch bis zur Duomatik reicht. Klein und handlich, elegant und repräsentativ, stylisch und modern: Die Knirps-Modelle decken die Bandbreite vom Klassiker bis zum Designaccessoire ab und sind in jedem Fall ein Highlight in den Sortimenten des Handels.

Viel Spaß beim Blättern in unserem neuen Katalog. Sie werden sehen, dass wir für jeden Geschmack, jede Gelegenheit und jedes Wetter den richtigen Schirm haben, alle in der bekannten Knirps Qualität.

PROTECTING YOU RELIABLY FOR MORE THAN 90 YEARS.

Innovation, development, improvement: that's the Knirps Credo. In 1928, this brand started a revolution with its groundbreaking umbrella design. More than 90 years later, Knirps still offers a wide range of products worldwide and has an unbroken record of success. Consistent brand leadership and innovative product development are our guarantees for sophisticated products with uniformly high quality, well-engineered functionality, and up-to-date design. Our inspiration comes from people's individual needs and preferences. Taking these into consideration, we developed a unique variety of products ranging from folding and stick umbrellas to manual and automatic umbrellas.

Small and handy, elegant and prestigious, stylish and modern: Knirps covers the design spectrum and always brings fresh ideas to the retail environment.

Have fun browsing our new catalogue. You will see that we have the right umbrella for every taste, every occasion and all types of weather – all of them in the well-known Knirps quality.



DER SCHIRM MIT DEM **ROTEN** PUNKT.

T.SERIES & TS.SERIES

Merkmale 06 – 09

Features

T.010	Small Manual	10 – 13
TS.010	Slim Small Manual	14 – 17
T.050	Medium Manual	18 – 21
T.200	Medium Duomatic	22 – 29
TS.200	Slim Medium Duomatic	30 – 31
T.300	Large Duomatic	32 – 33
T.400	Extra Large Duomatic	34 – 35
T.703	Stick Automatic	36 – 41
T.771	Long Automatic	42 – 43
T.900	Extra Long Automatic	44 – 45
T.903	Extra Long Automatic	46 – 47

S.SERIES

S.770 Long Automatic 48 – 49

SL SERIES

828 Topmatic SL Crook 50 – 51
923 Long Automatic 52 – 53

CONCEPT

811 X1 54 – 57
802 Floyd Manual 58 – 59

Modellübersicht 60 – 61
Product overview

POS Unterstützung 62 – 63
POS equipment

Geschichte 66
History

ZUVERLÄSSIGKEIT
dickere Wandstärken

RELIABILITY
thicker wall strength

LANGLEBIGKEIT
hochwertige
Materialzusammensetzung

DURABILITY
high quality materials

ZUVERLÄSSIGKEIT
verlängerte Gelenke

RELIABILITY
extended joints

LANGLEBIGKEIT
erhöhte Profiltiefe

DURABILITY
increased profile depth



Robuster und strapazierfähiger Materialmix
Sturdy and durable mix of materials



Windkanal getestet
Wind tunnel tested



Keine recycelten Materialien
No recycled materials



Abgerundete Schirmspitzen
Rounded safety tips



Schieber mit Gummieinlagen
Runner with rubber inlays

ZUVERLÄSSIGKEIT

- Alle unsere Modelle sind dank des ausgeklügelten Materialmixes äußerst stabil und langlebig.
- Um eine optimale Flexibilität zu bieten, werden alle unsere Produkte ausgiebig im Windkanal getestet.

RELIABILITY

- All of our models are very sturdy and extremely durable due to a sophisticated mix of materials.
- To ensure optimal flexibility, all of our products are thoroughly wind tunnel tested.

LANGLEBIGKEIT

- Optimierte Auswahl des Bezugstoffes für die 4-Sektionen Modelle.
- Erhöhte Strapazierfähigkeit durch Vermeidung recycelter Kunststoffe.
- Verwendung von leichtem, aber dennoch sehr stabilem und rostfreiem Flugzeugaluminium.

DURABILITY

- Optimized selection of the cover fabric for the 4-section models.
- Avoiding the use of recycled materials ensures increased durability.
- Use of aircraft grade aluminum which is light, strong and non-corrosive.

SICHERHEIT

- Dank abgerundeter Schirmspitzen ist die Verletzungsgefahr sehr gering.
- Alle Bezugstoffe unserer T.Series Regenschirme entsprechen dem Oeko-Tex® Standard 100.

SAFETY

- Rounded tips minimize the threat of eye injuries.
- All canopy fabrics of our T.Series umbrellas meet the Oeko-Tex® Standard 100.



Ergonomisch geformte Griffe
Ergonomically shaped handles



Leichtes Öffnen und Schließen
Effortless opening and closing



Futteral mit Reißverschluss
Zipper case



Extra breites Verschlussband
Extra wide tieband

KOMFORT

- Alle unsere Duomaticmodelle haben eine große Drucktaste, die sich leicht bedienen lässt. Dies wissen vor allem Frauen und Senioren zu schätzen.
- Für das Öffnen und Schließen des Schirms bedarf es nur eines geringen Kraftaufwands.
- Die ausreichend großen Griffe sind komfortabel und bieten einen exzellenten Tragekomfort.
- Alle Produkte werden mit einem Reißverschluss-Futteral geliefert.
- Alle Produkte der T.Series haben ein großes Schirmdach mit 7 bzw. 8 Segmenten. Alle Modelle der TS.Series bestehen aus 6 Segmenten um das flache Packmaß zu gewährleisten.

CONVENIENCE

- All of our Duomatic models have a large push button that guarantees easy handling. Especially women and senior citizens appreciate this feature.
- The umbrellas can be opened and closed with minimum effort.
- The handles are sufficient in size and offer excellent wearing comfort.
- All products come with a convenient zipper case.
- All T.Series models have a large canopy with 7 or 8 segments. All TS.Series models have 6 segments to ensure their flat packing size.



„Roter Punkt“ in Drucktaste
“Red Dot” in Push Button



Transparenter Schieber
Transparent runner



Konsistente Form- und Designsprache
Consistent form and design language



Futteral mit Reißverschluss
Zipper case

WIEDERERKENNBARKEIT

- Die auffallende, rote Drucktaste wird durch den Slogan „Der Schirm mit dem roten Punkt“ unterstützt.
- Alle Produkte haben eine einheitliche Form- und Designsprache.
- Knirps Produkte haben eine hohe Wiedererkennbarkeit und ein unverwechselbares Design.

RECOGNIZABILITY

- The distinctive red push button is conveyed by the “The umbrella with the red dot” catchphrase.
- All products offer a consistent form and design language.
- Knirps products have a high recognizability and distinctive designs.

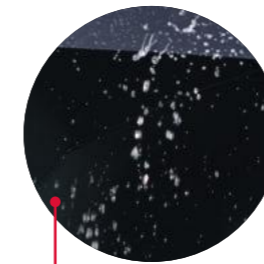

Schnelltrocknende Stoffe
Quick drying fabrics



Schieber mit Gummieinlagen
Runner with rubber inlays



Spezielle Webtechnik für Etiketten
Special weaving technique for labels

HAPTİK

- Transparente Schieber mit Gummieinlagen sorgen für einen sicheren Griff.
- Knirps verwendet nur hochwertigste Materialien und achtet auf jedes Detail.
- Die Etiketten sind mit einer speziellen Webtechnik gearbeitet.

HAPTICS

- The transparent runners have rubberized inlays for an improved grip.
- Knirps only uses high quality materials and pays great attention to detail.
- Labels are made with a special weaving technique.

T.SERIES & TS.SERIES

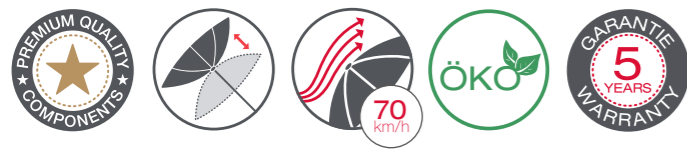

Hoher Tragekomfort dank extra langem Stock und komfortabler Griffgröße
 Comfortable to carry because of extra long shaft and ideal handle size

Extrem robuster Stock aus Flugzeugaluminium mit dickerer Wandstärke
 Extremely durable shaft made of aircraft grade aluminum with increased wall thickness



Silbernes Gestell
 Silver frame

Manuelle Bedienung
 Manually operated

Kleines Packmaß, überraschend großes Schirmdach
 Small pack size but surprisingly large canopy

T.010
 Art. Nr. 95 3010



5tlg. Aluminiumstock / 5-part aluminium shaft
 4tlg. Schiene aus Aluminium, Stahl und Fiberglas / 4-part ribs made of aluminium, steel and fibre-reinforced plastic

IMMER ZUR HAND
 ALWAYS AT HAND

LIGHT

NOS

T.010 SMALL MANUAL



95 3010 1000 | BLACK

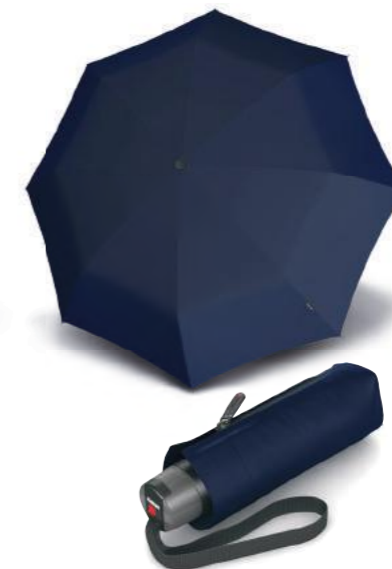

95 3010 1200 | NAVY



95 3010 1510 | DARK RED



95 3010 1600 | TAUPE

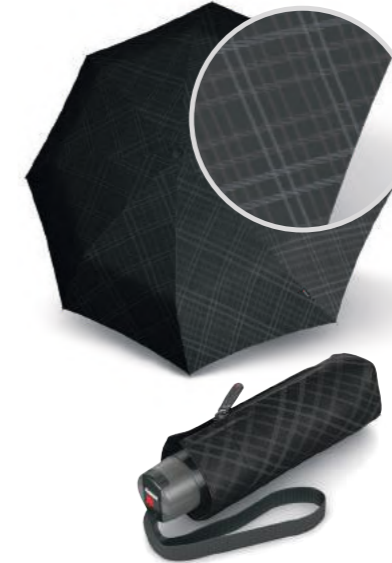

95 3010 7050 | MODERN BLACK

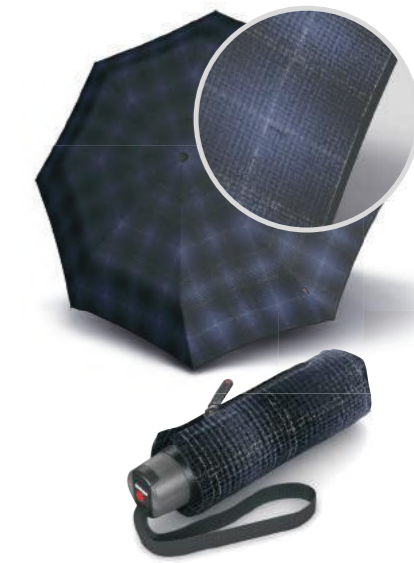

95 3010 7051 | MODERN BLUE



95 3010 4011 | ID WHIRLS



95 3010 4020 | ID STRIPE



95 3010 4031 | ID GREY



95 3010 4901 | DOT ART BLACK



95 3010 4902 | DOT ART TAUPE



95 3010 4903 | DOT ART RED

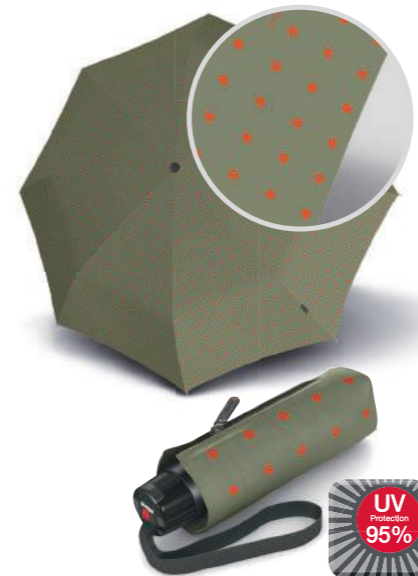

95 3010 4106 | KELLY SAND



95 3010 4107 | KELLY DARK NAVY



95 3010 4108 | KELLY BLUE



95 3010 4045 | ID RED



95 3010 4050 | ID BLACK

SPRING | SUMMER 2019

SOLIDS



95 3010 8300 | VIOLET



95 3010 8301 | SKY



95 3010 8302 | SUN

PRIMROSE



95 3010 4905 | STRIPE RED



95 3010 4906 | STRIPE BLUE



95 3010 8323 | PINK



95 3010 8324 | BLUE



95 3010 8325 | NUDE

T.SERIES & TS.SERIES



REISE
ACCESSOIRE
TRAVEL
COMPANION

FLACH
FLAT

Robuste Stoffqualität
Robust fabric quality

Langer Stock für angenehmen Tragekomfort
Long stick for pleasant wearing comfort

Leichtes Verstauen des Schirmes
dank Reißverschlussfutteral
Easy storage of the umbrella
thanks to its zipper case

TS.010
Art. Nr. 95 4010

Einfache Bedienung durch
Tastenschieber
Easy handling with push button runner

12-Kantstock und massive Messingnieten
12-edge stick and massive brass rivets



5tlg. Aluminiumstock / 5-part aluminium shaft

4tlg. Schiene aus Aluminium, Stahl und Fiberglas / 4-part ribs made of aluminium, steel and fibre-reinforced plastic

NOS

TS.010 SLIM SMALL MANUAL



95 4010 1000 | BLACK



95 4010 1200 | NAVY



95 4010 1510 | DARK RED



95 4010 4020 | ID STRIPE



95 4010 4933 | BOLERO BLACK ECRU



95 4010 4935 | BOLERO TAUPE

SUPERTHIN



95 4010 1001 | BLACK



95 4010 2100 | NAVY



95 4010 2000 | RED

FLORA



95 4010 8309 | MULTICOLOUR



95 4010 8310 | PASTELL



SUPERTHIN



95 4010 4800 | LOTOUS BLACK

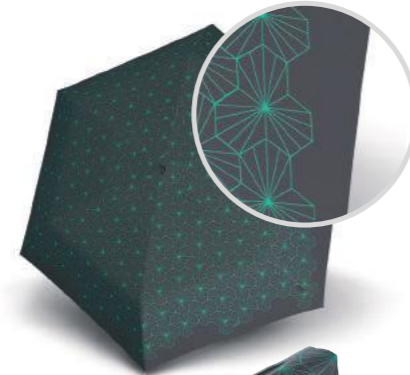

95 4010 4801 | LOTOUS IRON



95 4010 4993 | FLAKES RED

LILY

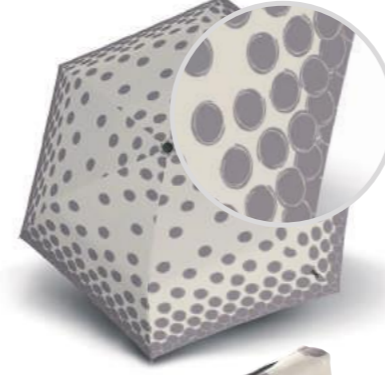

95 4010 8326 | STONE

NUNO



95 4010 8313 | DROPLETS



LEICHTERE
STOFFQUALITÄT FÜR
SCHLANKERES PACKMASS

EXTRA SLIM
WHEN FOLDED DUE TO
SUPERTHIN FABRIC

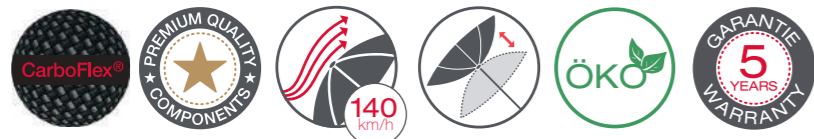

watch the video
windtunnel

Leichtester manueller Knirps Schirm
Lightest manual Knirps umbrella

Erhöhte Stabilität dank CarboFlex® Technologie
Increased stability due to CarboFlex® Technology

EINFACHE
BEDIENUNG
EASY HANDLING

LEICHT
LIGHT
193 G
6.80 OZ



Schlankes Packmaß dank besonderer
Schienenkonstruktion
Slim packing thanks
to special rib construction

T.050
Art. Nr. 95 3050

Schwarzes Gestell
Black frame

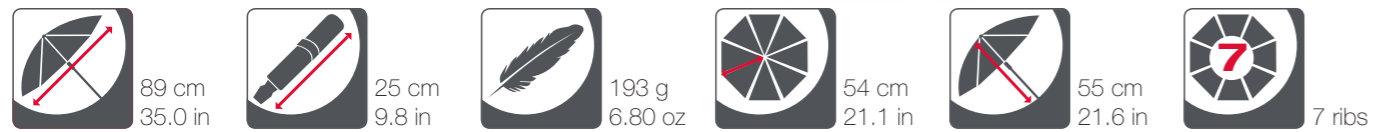

3tlg. Aluminiumstock / 3-part aluminium shaft
3tlg. Vollkarbonschiene / 3-part carbon rib

NOS

T.050 MEDIUM MANUAL

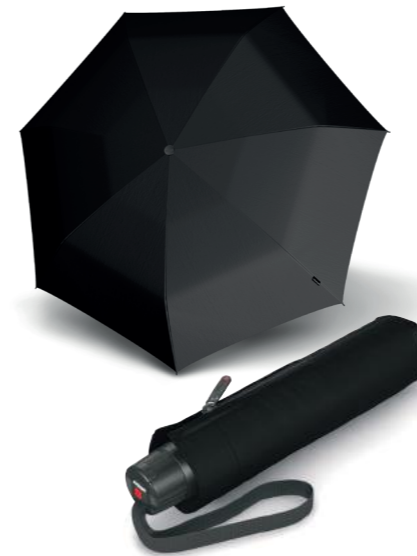

95 3050 1000 | BLACK



95 3050 1510 | DARK RED



95 3050 4933 | BOLERO BLACK ECRU



95 3050 4935 | BOLERO TAUPE



8830505
T.050 Carboflex® Flyer
ca. 13 x 18 cm



Schirmfarben vom Fotoshooting können wegen Lichteinstrahlung abweichen. Imagebild zeigt Designnr. 8321
 Umbrella colors from the photo shooting may differ as a result of lighting. Image picture shows design number 8321



POPY

95 3050 8317 | ROSE



95 3050 8318 | PURPLE

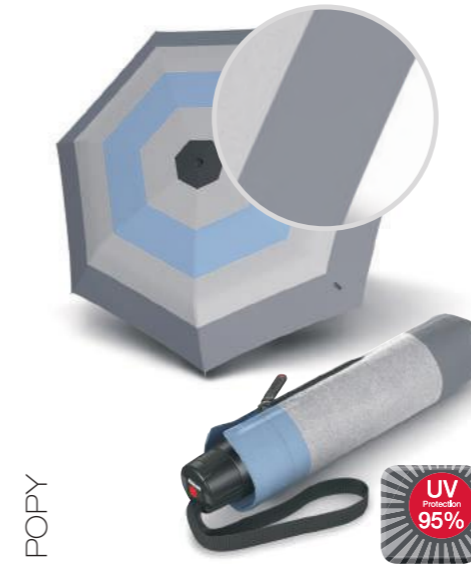

POPY

95 3050 8319 | LIGHT BLUE

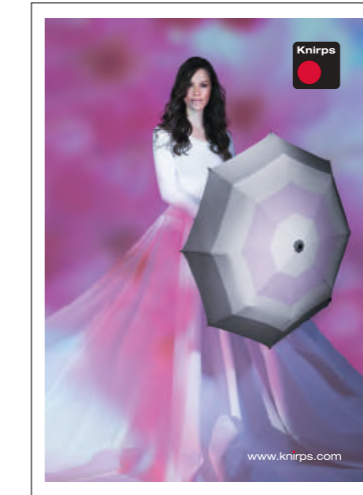

Knirps Poster DIN A3
Art. No. 8883183



CALA

95 3050 8320 | STONE



95 3050 8321 | BLUE



95 3050 8322 | BLACK

T.SERIES & TS.SERIES

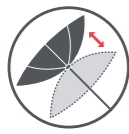

watch the video
windtunnel

KOMPAKT & KOMFORTABEL
COMPACT & COMFORTABLE

EASY HANDLING

Vergrößerte Schienenprofile für maximale Stabilität bei jeder Windrichtung
Increased rib profile for maximum rigidity for every wind direction



Silbernes Gestell
Silver frame

Extrem leichtgängige Duomatic-Funktion mit 30% geringerem Kraftaufwand
Extremely smooth-running Duomatic function requiring 30% less effort

T.200

Art. Nr. 95 3200

Robuster Stock aus Aluminium mit 20% mehr Wandstärke
Durable shaft made of aircraft grade aluminium with 20% increased wall thickness

Dreigeteilte Schienen erleichtern das Falten des Schirms
3-section ribs assist with easy folding



98 cm
38.5 in



28 cm
11.0 in



320 g
11.29 oz



53 cm
20.8 in



56 cm
22.2 in



8 ribs

3tlg. Aluminiumstock / 3-part alushaft
3tlg. Schiene aus Aluminium und Fiberglas / 3-part ribs made of aluminium and fibre-reinforced plastic

NOS

T.200 MEDIUM DUOMATIC



95 3200 1000 | BLACK



95 3200 1200 | NAVY



95 3200 1500 | RED



95 3200 5570 | CHECK BLACK & BLUE



95 3200 5180 | CHECK BLUE & GREEN



95 3200 5190 | CHECK RED



95 3200 5280 | CHECK BLACK & WHITE



95 3200 5290 | CHECK BLACK



95 3200 5380 | CHECK TOFFEE



95 3200 5390 | CHECK BEIGE



95 3200 5990 | CHECK NAVY



95 3200 5181 | CHECK HUNTER



95 3200 4901 | DOT ART BLACK



95 3200 4902 | DOT ART TAUPE



95 3200 4903 | DOT ART RED



95 3200 5991 | CHECK GREY



95 3200 4101 | GRACE BLACK



95 3200 4102 | GRACE SAND



95 3200 4107 | KELLY DARK NAVY



95 3200 4108 | KELLY BLUE

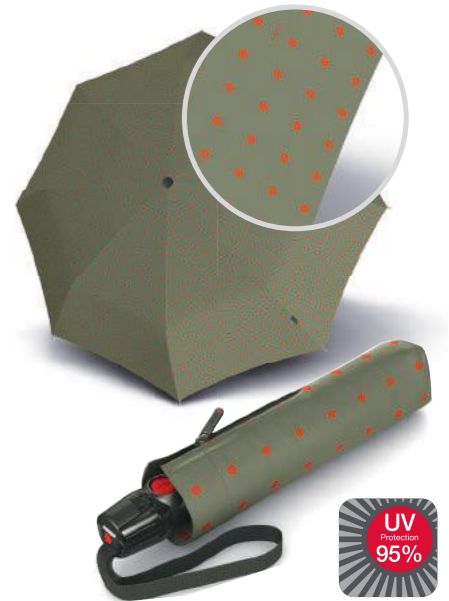

95 3200 4106 | KELLY SAND



95 3200 4103 | GRACE NAVY



95 3200 4104 | GRACE BLUE



95 3200 4939 | ANIMAL STONE



95 3200 4930 | ANIMAL TAUPE



95 3200 4937 | COMET NAVY



95 3200 4938 | COMET CREME



95 3200 7056 | BAKER STREET AQUA



95 3200 7057 | WATSON AQUA

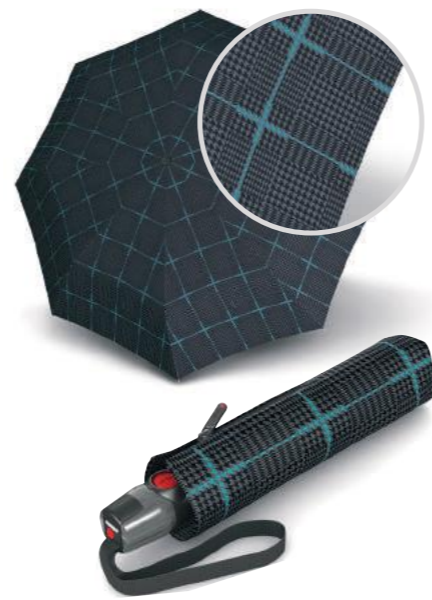

95 3200 7058 | SHERLOCK AQUA



95 3200 7151 | REFLECTIVE BLACK



95 3200 4109 | GATSBY BLACK



95 3200 7052 | BAKER STREET TOBACCO



95 3200 7053 | WATSON TOBACCO

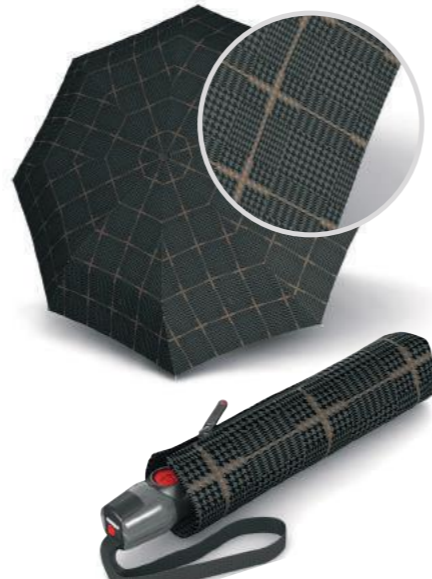

95 3200 7054 | SHERLOCK TOBACCO

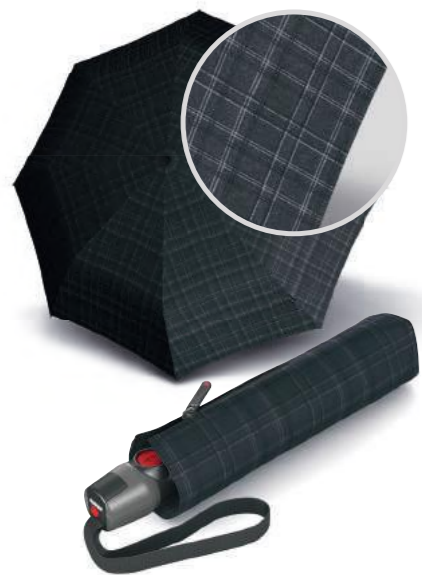

95 3200 7600 | VE 3 MEN'S PRINTS



Schirmfarben vom Fotoshooting können wegen Lichteinstrahlung abweichen. Imagebild zeigt Designnr. 7053
Umbrella colors from the photo shooting may differ as a result of lighting. Image picture shows design number 7053

DHALIA



95 3200 8303 | BLACK



95 3200 8304 | VIOLET



95 3200 8305 | MINT

CALA



95 3200 8320 | STONE



95 3200 8321 | BLUE



95 3200 8322 | BLACK

LIANA



95 3200 8307 | BLACK



95 3200 8308 | BLUE

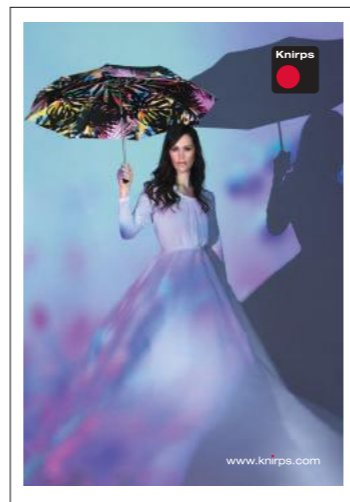

Knirps Poster DIN A3
Art. No. 8883073

PRIMROSE



95 3200 8323 | PINK



95 3200 8324 | BLUE



95 3200 8325 | NUDE

POPY



95 3200 8317 | ROSE



95 3200 8318 | PURPLE

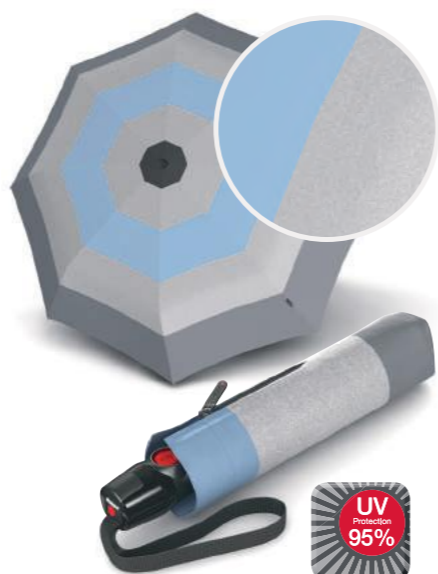

95 3200 8319 | LIGHT BLUE

NUNO



95 3200 8314 | SPRAY



95 32000 8315 | DOWNPOUR

T.SERIES & TS.SERIES



PASST IN DIE AKTENTASCHE
FITS INTO YOUR BRIEFCASE

FLACH
FLAT

Mittlere Schiene hat ein Kunststoffgelenk, das die Flexibilität und somit die Langlebigkeit erhöht
The middle part of the rib has a plastic joint which increases the flexibility and therefore the durability



Erhöhte Stabilität, da das Stockteil am Griffende aus Stahl gearbeitet ist
Increased stability as the shaft at the end of the handle is made out of steel

Schwarzes Gestell
Black frame

Große Auslösetaste erleichtert die Bedienung
Easy handling thanks to big push button

TS.200
Art. Nr. 95 4200



3tlg. Stock aus Aluminium und Stahl / 3-part shaft made of aluminium and steel
3tlg. Schiene aus Aluminium und Fiberglas / 3-part ribs made of aluminium and fibre-reinforced plastic

NOS

TS.200 SLIM MEDIUM DUOMATIC



95 4200 1000 | BLACK



95 4200 1200 | NAVY



95 4200 1500 | RED



95 4200 4020 | ID STRIPE



95 4200 4933 | BOLERO BLACK ECRU



95 4200 4935 | BOLERO TAUPE

SPRING | SUMMER 2019



PRIMROSE

95 4200 8323 | PINK



95 4200 8324 | BLUE



95 4200 8325 | NUDE

T.SERIES & TS.SERIES

S.SERIES

SL.SERIES

CONCEPT

POS

HISTORY

T.SERIES & TS.SERIES

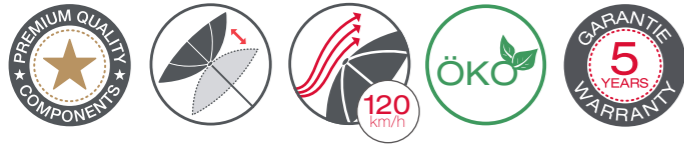

DER SCHIRM FÜR DEN MANN
MEN'S CHOICE

DETAIL VERLIEBT
ATTENTION TO DETAIL

Ideale Dachgröße und langer Stock für angenehmen Tragekomfort
Ideal canopy size and long shaft for pleasant wearing comfort

Edelstahl-Zugstangen für mehr Langlebigkeit
Stainless steel rods for high durability

Torsionsring am Stock für erhöhte Stabilität
Torsion ring on the shaft for increased stability

Dreigeteilte Schienen erleichtern das Falten des Schirms
Three-section ribs facilitate the folding of the umbrella

Schwarzes Gestell
Black frame



Massive Metallgelenke garantieren Windstabilität
Massive metal joints guarantee wind stability



3tlg. Stahlstock / 3-part steelshaft
3tlg. Schiene aus Polyamid und Fiberglas / 3-part ribs made of polyamid and fibre-reinforced plastic

NOS

T.300 LARGE DUOMATIC



95 3300 1000 | BLACK

95 3300 5290 | CHECK BLACK

95 3300 7042 | CUBE GREY

95 3300 7052 | BAKER STREET TOBACCO

95 3300 7053 | WATSON TOBACCO

95 3300 7054 | SHERLOCK TOBACCO

95 3300 7056 | BAKER STREET AQUA

95 3300 7057 | WATSON AQUA

95 3300 7058 | SHERLOCK AQUA

T.SERIES & TS.SERIES

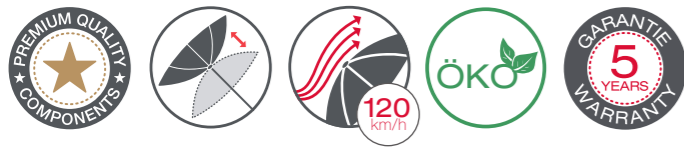

Spezielle Kunststoffmischung garantiert optimales Gewicht, Robustheit und Langlebigkeit der Schienen
 Specific synthetic mix for optimal weight, sturdiness and durability of the ribs

REGENSCHUTZ IM GROSSEN STIL
 RAIN PROTECTION ON THE LARGE SCALE

XXL

Schwarzes Gestell
 Black frame

Größtes Duomaticmodell in Taschengröße bietet Schutz für 2 Personen
 Largest Duomatic model in pocket size offers cover for 2 persons

T.400
 Art. Nr. 95 3400

Ergonomisch geformter Griff
 Ergonomically shaped handle

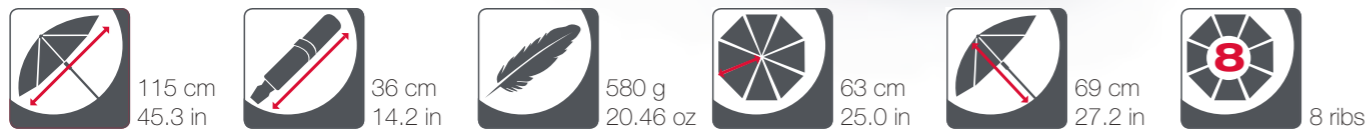

3tlg. Stahlstock / 3-part steelshaft
 3tlg. Schiene aus Stahl, Polyamid und Fiberglas / 3-part ribs made of steel, polyamid and fibre-reinforced plastic

NOS

T.400 EXTRA LARGE DUOMATIC



95 3400 1000 | BLACK

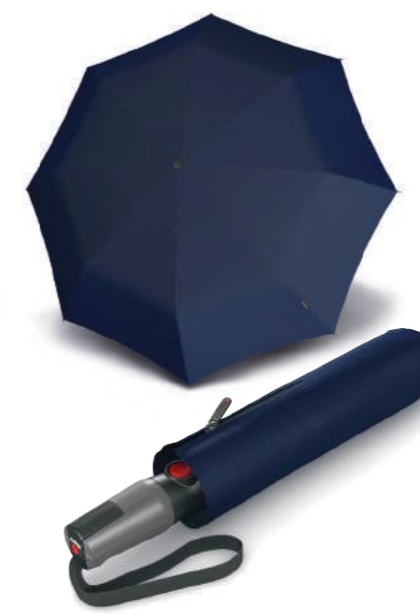

95 3400 1200 | NAVY

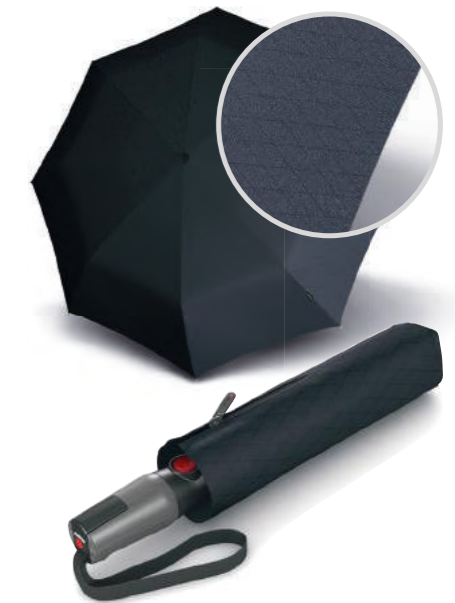
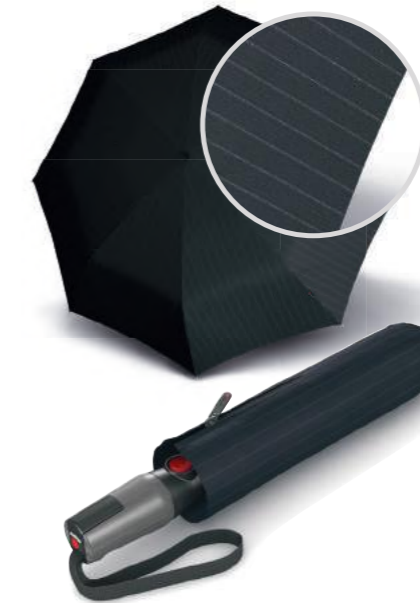
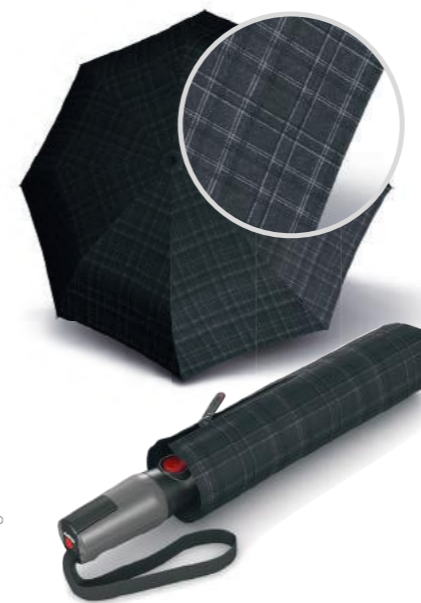

95 3400 7600 | VE 3 MEN'S PRINTS

Schirmfarben vom Fotoshooting können wegen Lichteinstrahlung abweichen. Imagebild zeigt Designnr. 1000
 Umbrella colors from the photo shooting may differ as a result of lighting. Image picture shows design number 1000



T.SERIES & TS.SERIES

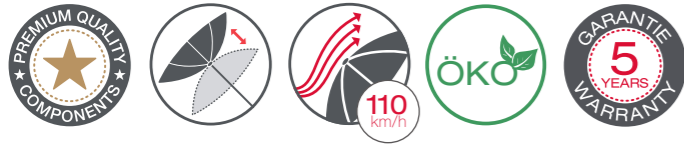

KLASSIKER
MIT KOMFORT
A COMFORTABLE
CLASSIC

LIGHT

Krone aus Metall für Langlebigkeit
durability thanks to a notch made of metal



Klassiker mit großem Dach für Damen und Herren
Classic model with large canopy for women and men

Schwarzes Gestell
Black frame

Komfortabler Öffnungsmechanismus mit einhändig
bedienbarer Auslösetaste in angenehmer Höhe
Comfortable opening mechanism with conveniently
placed push button that can be operated one-handed

Leichtester Langschirm mit Automatikfunktion
Lightest stick umbrella with automatic function

T.703
Art. Nr. 96 3703



Stahlstock mit Fiberglasschiene / Steel shaft and fibre-reinforced plastic rib

NOS

T.703 STICK AUTOMATIC



96 3703 1000 | BLACK

96 3703 1200 | NAVY

96 3703 5190 | CHECK RED



96 3703 5280 | CHECK BLACK & WHITE

96 3703 5390 | CHECK BEIGE

96 3703 5480 | CHECK NAVY & BORDEAUX



96 3703 5570 | CHECK BLACK & BLUE

96 3703 5380 | CHECK TOFFEE



Schirmfarben vom Fotoshooting können wegen Lichteinstrahlung abweichen. Imagebild zeigt Designnr. 4020
 Umbrella colours from the photo shooting may differ as a result of lighting. Image picture shows design number 4020



96 3703 4901 | DOT ART BLACK



96 3703 4902 | DOT ART TAUPE



96 3703 4020 | ID STRIPE



96 3703 4101 | GRACE BLACK



96 3703 4102 | GRACE SAND



96 3703 4109 | GATSBY BLACK

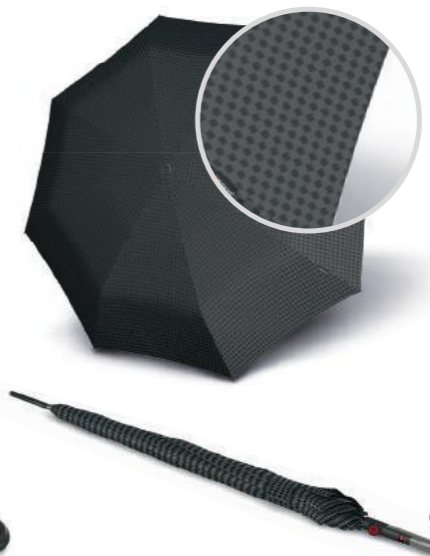

96 3703 7042 | CUBE GREY



96 3703 7050 | MODERN BLACK



LIANA

96 3703 8307 | BLACK



96 3703 8308 | BLUE

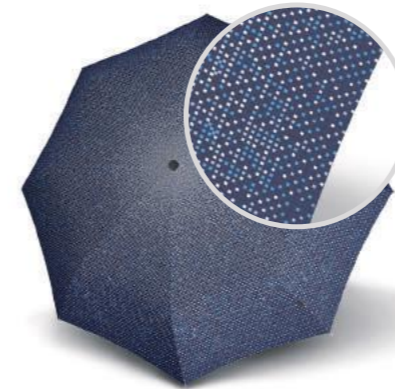

NUNO

96 3703 8314 | SPRAY

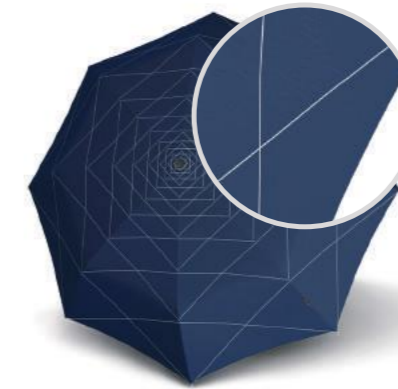

96 3703 8315 | DOWNPOUR

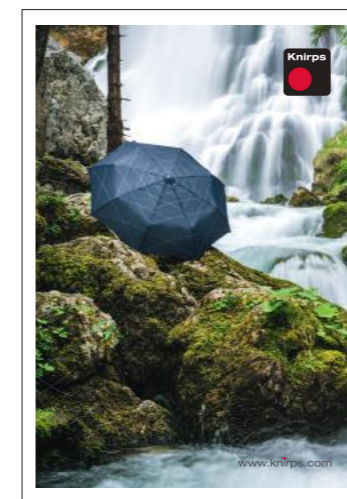

Knirps Poster DIN A3
Art. No. 8883153

Schirmfarben vom Fotoshooting können wegen Lichteinstrahlung abweichen. Imagebild zeigt Designnr. 8307
Umbrella colours from the photo shooting may differ as a result of lighting. Image picture shows design number 8307

T.SERIES & TS.SERIES



KLASSIKER FÜR ZWEI
A CLASSIC FOR TWO

IMMER
ZUVERLÄSSIG
ALWAYS
RELIABLE

Kaum ein Überschlagen des Daches, da die Konstruktion windresistent ist
Hardly any flipping over of the canopy as the construction is wind resistant

Großer Schieber ermöglicht ein Öffnen und Schließen mit nur geringem Kraftaufwand
Large runner enables opening and closing with little effort

Futteral mit Druckknopf schützt das Schirmdach zuverlässig vor Beschädigungen
Case with push button protects the canopy reliably from damage

T.771
Art. Nr. 96 3771

Rundhakengriff aus echtem Ahornholz
Crookhandle made from real maple wood



Stahlstock mit Stahlschienen / steel shaft and steel rib

NOS

T.771 LONG AUTOMATIC



96 3771 1000 | BLACK

96 3771 7603 | PATTERN



96 3771 7600 | VE 3 MEN'S PRINTS

verfügbar ab Mai 2019 | available in May 2019

T.SERIES & TS.SERIES

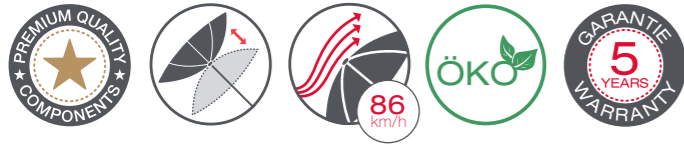

Robuster Stahlstock mit Metallkappende für eine lange Lebensdauer
Steel shaft with metal cap for outstanding durability

Flexible Hilfspfeiler erhöhen die Langlebigkeit
Flexible stretchers increase the durability



Das Futteral schützt den Schirm und sorgt für einen eleganten Auftritt
The case protects the umbrella and allows an elegant appearance

Verstärkte Gelenke in den Schienen sichern bei starker Belastung
Reinforced rib joints secure during heavy strain

Angenehmes Schließen durch großen Schieber mit Gummieinlagen
Comfortable to close because of large runner with rubber inlays

Ergonomisch geformter Stabgriff mit Handschleife
Ergonomically shaped handle with wristband

ELEGANTER AUFTRITT FÜR ZWEI
AN ELEGANT APPEARANCE FOR TWO

EXTREM ROBUST
EXTREMELY ROBUST

T.900
Art. Nr. 96 3900



Stahlstock mit Fiberglasschiene / Steel shaft and fibre-reinforced plastic rib

NOS

T.900 EXTRA LONG AUTOMATIC



96 3900 1000 | BLACK

Schirmfarben vom Fotoshooting können wegen Lichtstrahlung abweichen. Imagebild zeigt Designnr. 1000
Umbrella colors from the photo shooting may differ as a result of lighting. Image picture shows design number 1000



T.SERIES & TS.SERIES

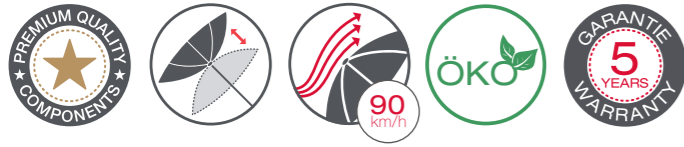

REGENSCHUTZ
FÜR ZWEI
RAIN PROTECTION
FOR TWO

IMMER
ZUVERLÄSSIG
ALWAYS
RELIABLE

Robuster Stahlstock mit Metallkappenende für eine lange Lebensdauer
Steel shaft with metal cap for outstanding durability

Verstärkte Gelenke in den Schienen sichern bei starker Belastung
Reinforced rib joints secure during heavy strain

Flexible Hilfspfeiler erhöhen die Langlebigkeit
Flexible stretchers increase the durability



Extra große, abgerundete Schirmspitzen
Extra large safety tips

T.903
Art. Nr. 96 3903

Komfortabler Öffnungsmechanismus
mit einhändig bedienbarer Auslösetaste
in angenehmer Position
Comfortable opening mechanism with
conveniently placed push button that can
be operated one-handed

Angenehmes Schließen durch großen Schieber mit Gummieinlagen
Comfortable to close because of large runner with rubber inlays

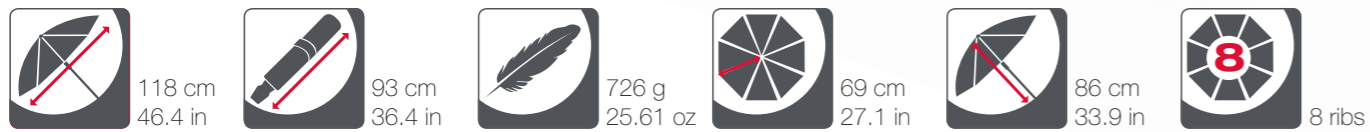

Stahlstock mit Fiberglasschiene / Steel shaft and fibre-reinforced plastic rib

NOS

T.903 EXTRA LONG AUTOMATIC



96 3903 1000 | BLACK



Schirmfarben vom Fotoshooting können wegen Lichteinstrahlung abweichen. Imagebild zeigt Designnr. 1000
Umbrella colors from the photo shooting may differ as a result of lighting. Image picture shows design number 1000

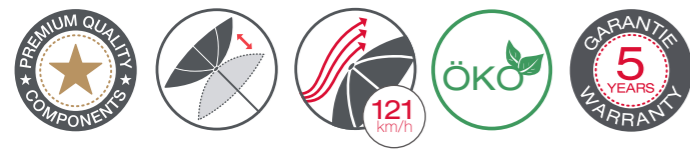

Krone aus Metall
Die derzeit stabilste und langlebigste Variante einer Krone
Top notch made of metal
The most stable and most durable top notch version on the market



Großer Schieber ermöglicht ein Öffnen und Schließen mit nur geringem Kraftaufwand
Large runner enables opening and closing with little effort

Kaum ein Überschlagen des Daches, da die Konstruktion windresistent ist
Hardly any flipping over of the canopy as the construction is wind resistant

Futteral mit Druckknopf schützt das Schirmdach zuverlässig vor Beschädigungen
Case with push button protects the canopy reliably from damage

S.770

Art. Nr. 96 5770

Aufwändig per Hand montierte Metallplakette am Griff
Metal plaque on the handle, elaborately mounted by hand

Angenehm in der Hand liegender Rundhakengriff aus italienischem Ahornholz
Comfortable hook handle made out of Italian maple wood



Stahlstock / steel shaft
Stahlschiene / steel rib

NOS

S.770 LONG AUTOMATIC



96 5770 1000 | BLACK



96 5770 7601 | CHECK

96 5770 7602 | STRIPE

96 5770 7603 | PATTERN

- Ausschließlich italienisches Ahornholz aus nachhaltiger Forstwirtschaft
- 31 Arbeitsschritte von der Bohle bis zum fertigen Griff
- 1 m³ Holz ergibt 600-700 Knirps Rundhaken Griffe
- Jeder Griff ist ein Unikat; echte deutsche Handwerkskunst, von Hand geflammt

- Italian maple wood from sustainable forestry only
- 31 steps from the plank to the finished handle
- 1 m³ wood results in 600-700 Knirps rounded handles
- Every handle is unique; genuine German craftsmanship, flamed by hand

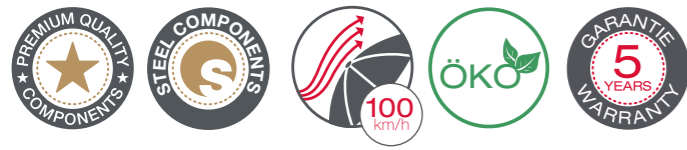

EXTREM ROBUST
EXTREMELY ROBUST

XXL

Elegante, ansprechende Dachform
Elegant, appealing canopy shape

Großer Schieber
Large runner

Schließt und öffnet mit
geringstem Kraftaufwand
Opens and closes with
minimal effort

Angenehm in der Hand liegender
Rundhakengriff aus Ahornholz.
Jeder Griff ist ein Einzelstück:
Abweichung in Farbe und Maserung möglich
Crock handle made of maple wood lies
comfortably in the hand.
Every handle is unique therefore deviations
in color and wood grain are possible.



Topmatic SL Crock

Art. Nr. 89 828

Extra große Auslösetaste
Extra large push button

NOS

828 TOPMATIC SL CROOK



89 828 710 | BLACK



89 828 4109 | GATSBY



89 828 420 | PINSTRIPE NAVY



89 828 529 | CHECK BLACK



89 828 539 | CHECK BEIGE



2 tlg. Stahlstock / 2-part steel shaft
2 tlg. Stahlschiene / 2-part steel rib

SL SERIES

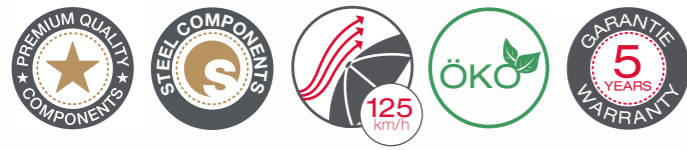

STILVOLLER
HERRENSCHIRM
STYLISH
MAN'S UMBRELLA

XXL

Krone aus Metall
Die derzeit stabilste und
langlebigste Variante einer Krone
Top notch made of metal
The most stable and most durable
top notch version on the market



Robuster Stahlstock erlaubt Stützfunktion
Robust steel shaft allows supporting function

Angenehm in der Hand liegender
Echtholzgriff aus Ahorn
Handle made from real maple wood
lies comfortably in hand

Long Automatic

Art. Nr. 79 923

Fiberglaseinlage in der
Stahlschiene für erhöhte Flexibilität
Steel ribs with fiberglass inlay
for more flexibility

Futteral schützt den Schirm
zuverlässig vor Beschädigungen
Case reliably protects umbrella
from damage



Stahlstock / steel shaft
Stahlschiene / steel rib

NOS

923 LONG AUTOMATIC



79 923 518 | CHECK BLUE & GREEN

79 923 539 | CHECK BEIGE

79 923 557 | CHECK BLACK & BLUE

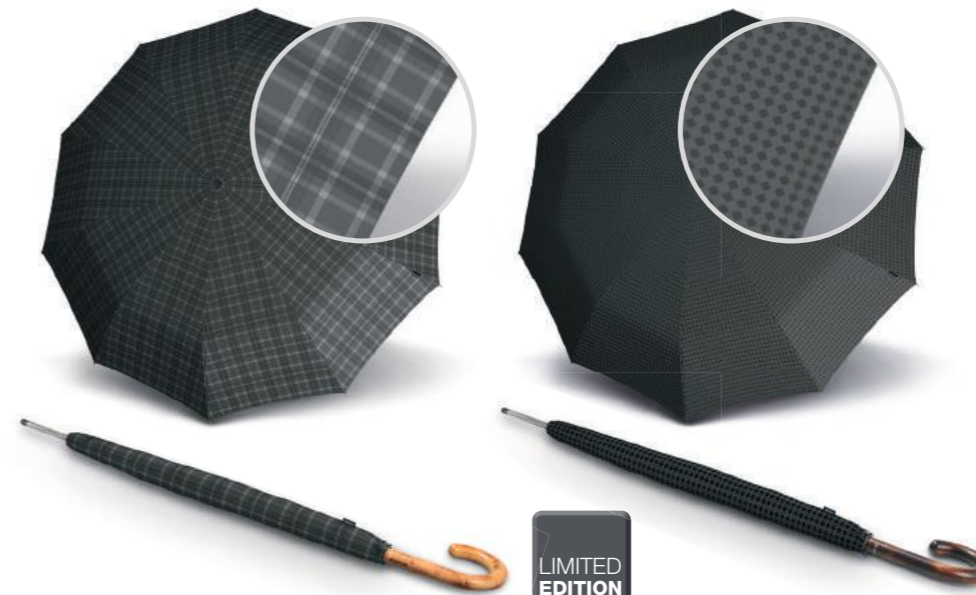

79 923 558 | CHECK GREY

79 923 7042 | CUBE GREY



79 923 740 | VE 3 MEN'S PRINTS

CONCEPT

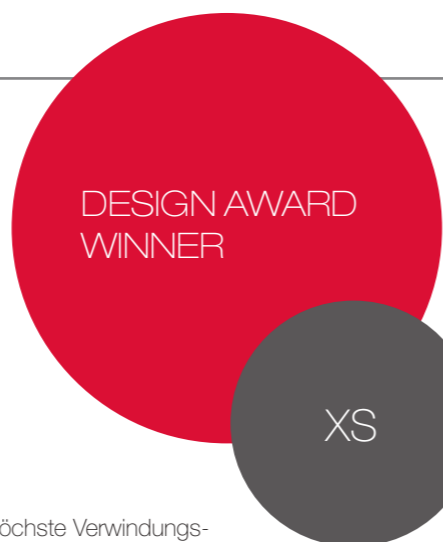

12-Kantstock für höchste Verwindungsstabilität auch bei starkem Wind
12-edged shaft for maximum torsional stability even in high winds

Langer Stock für angenehmen Tragekomfort
Long shaft for pleasant wearing comfort

Sehr leichter Stoff aus extra feinem Garn für ein extrem schlankes Packmaß
Extremely light-weight fabric made of fine yarn for a slim pack size

Extrem leicht durch Aluminium
Extremely lightweight due to aluminum

X1
Art. Nr. 89 811



Einfache Bedienung durch Tastenschieber
Easy handling thanks to pushbutton runner

Schirmetui kann mit einer Schlaufe an einer Aktentasche oder einem Rucksack befestigt werden
Umbrella case has a loop to attach it to a briefcase or a backpack



5tlg. Aluminiumstock / 5-part aluminium shaft
4tlg. Schiene aus Aluminium, Stahl und Fiberglas / 4-part ribs made of aluminium, steel and fibre-reinforced plastic

NOS

811 X1



89 811 100 | BLACK/NIGHT

89 811 200 | HEART

89 811 210 | NAVY



89 811 1300 | PINK

89 811 1800 | LEMON

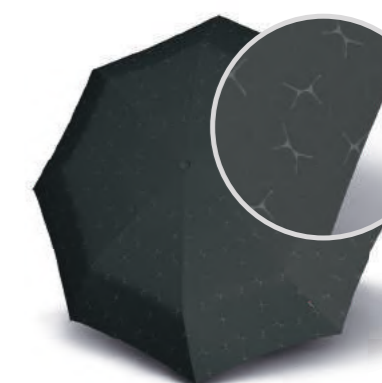
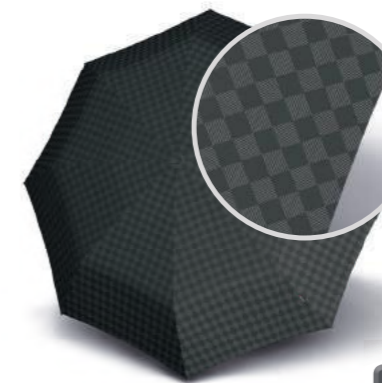
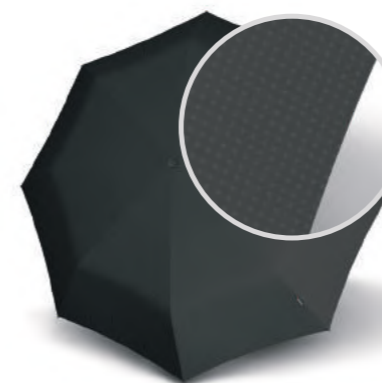

89 811 110 | MAT CROSS

89 811 618 | FUNKY CHESS

89 811 620 | SPLASH

T-SERIES & T-SERIES

S-SERIES

SL-SERIES

CONCEPT

POS

HISTORY



89 811 300 | NAVY DOT



89 811 4990 | FLAKES BLACK



89 811 4993 | FLAKES RED



FLORA

89 811 8309 | MULTICOLOUR



89 811 8310 | PASTELL



89 811 4800 | LOTOUS BLACK



89 811 4801 | LOTOUS IRON



LILY

89 811 8326 | STONE



89 811 8327 | BLUE



89 811 8234 | NUNO SNOW



89 811 4991 | KEY BLACK



NUNO

89 811 8313 | DROPLETS



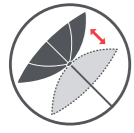

AUCH FÜR SCHUL-
KINDER GEEIGNET
SUITABLE FOR
SCHOOL CHILDREN

EASY
HANDLING

Materialmix mit hohem Kohlenanteil in Einzelkomponenten der Schienen
Material blend with high carbon content in single components of the ribs

Abgerundete, vergrößerte Schirmspitzen zur Vermeidung von Augenverletzungen
Larger, rounded umbrella tips prevent eye injuries



Einzigartige Griffgestaltung
Unique handle shape

Große Farbauswahl
Wide choice of colours

Floyd
Art. Nr. 89 802

Hochqualitative Kunststoffe gewährleisten Bruchsicherheit
Advanced plastics assure increased resistance to breakage



94 cm
37.0 in



27 cm
10.6 in



260 g
9.17 oz



51 cm
20.0 in



57 cm
22.4 in



ribs

3tlg. Stahlstock / 3-part steelshaft
3tlg. Schiene aus Aluminium und Fiberglas / 3-part ribs made of aluminium and fibre-reinforced plastic



89 802 100 | BLACK



89 802 105 | WHITE



89 802 121 | BLUE



89 802 133 | PINK



89 802 134 | CAPRI



89 802 135 | YELLOW



89 802 150 | RED



89 802 300 | ORANGE



89 802 170 | VIOLET























89 802 270 | GREEN



Damit Ihr Knirps Schirm als treuer Begleiter für viele Jahre zuverlässigen Schutz bieten kann, sollte er nach jedem Gebrauch aufgespannt trocknen. Erst wenn jegliche Feuchtigkeit verfliegen ist, sollte der Schirm wieder zusammengeklappt und in seine Schutzhülle verstaut werden.

In order for your Knirps umbrella to be a trustworthy companion offering cover for many years, it should be opened for complete drying after each use. Only when all moisture has evaporated should the umbrella be folded closed and stored in its case.

CONCEPT		T SERIES & TS SERIES						S SERIES	SL SERIES						
 manual		 manual		 duomatic				 automatic							
															
Design Award Winner	school children	flat	light	lightest	light	easy handling	man's choice	XXL	light	light	robust	rain protection for two	handle made in Germany	extremely robust	extremely robust
811 X1	802 Floyd	TS.010 Slim Small Manual	T.010 Small Manual	T.050 Medium Manual	TS.200 Slim Medium Duomatic	T.200 Medium Duomatic	T.300 Large Duomatic	T.400 Extra Large Duomatic	T.703 Stick Automatic	T.771 Long Automatic	T.900 Extra Long Automatic	T.903 Extra Long Automatic	S.770 Long Automatic	828 Topmatic SL Crook	923 Long Automatic
94 cm 37.0 in	94 cm 37.0 in	94 cm 37.0 in	94 cm 37.0 in	89 cm 35.0 in	97 cm 38.2 in	98 cm 38.5 in	105 cm 41.3 in	115 cm 45.3 in	105 cm 41.3 in	111 cm 43.7 in	118 cm 46.4 in	118 cm 46.4 in	111 cm 43.7 in	102 cm 40.2 in	111 cm 43.7 in
18 cm 7.1 in	27 cm 10.6 in	18 cm 7.1 in	18 cm 7.1 in	25 cm 9.8 in	29 cm 11.4 in	28 cm 11.0 in	30 cm 11.9 in	36 cm 14.2 in	88 cm 34.7 in	91 cm 35.8 in	93 cm 36.4 in	93 cm 36.4 in	92 cm 36.2 in	42 cm 16.3 in	92 cm 36.2 in
280 g 9.87 oz	260 g 9.17 oz	220 g 7.76 oz	255 g 8.99 oz	193 g 6.80 oz	290 g 10.23 oz	320 g 11.29 oz	510 g 17.99 oz	580 g 20.46 oz	510 g 17.99 oz	604 g 21.31 oz	684 g 24.13 oz	726 g 25.61 oz	650 g 22.9 oz	530 g 18.7 oz	650 g 22.90 oz
8 Schienen 8 ribs	8 Schienen 8 ribs	6 Schienen 6 ribs	8 Schienen 8 ribs	7 Schienen 7 ribs	6 Schienen 6 ribs	8 Schienen 8 ribs	8 Schienen 8 ribs	8 Schienen 8 ribs	8 Schienen 8 ribs	10 Schienen 10 ribs	8 Schienen 8 ribs	8 Schienen 8 ribs	10 Schienen 10 ribs	8 Schienen 8 ribs	10 Schienen 10 ribs
53 cm 20.9 in	57 cm 22.4 in	54 cm 21.3 in	54 cm 21.5 in	54 cm 21.1 in	56 cm 22.0 in	56 cm 22.2 in	59 cm 23.4 in	69 cm 27.2 in	77 cm 30.2 in	82 cm 32.3 in	85 cm 33.5 in	86 cm 33.9 in	81 cm 31.9 in	62 cm 24.2 in	81 cm 31.9 in
52 cm 20.5 in	51 cm 20.0 in	52 cm 20.4 in	52 cm 20.4 in	54 cm 21.1 in	53 cm 20.9 in	53 cm 20.8 in	58 cm 22.8 in	63 cm 25.0 in	59 cm 23.2 in	61 cm 24.0 in	69 cm 27.1 in	69 cm 27.1 in	62 cm 24.4 in	55 cm 21.6 in	62 cm 24.4 in
Seite 54-57	Seite 58-59	Seite 14-17	Seite 10-13	Seite 18-21	Seite 30-31	Seite 22-29	Seite 32-33	Seite 34-35	Seite 36-41	Seite 42-43	Seite 44-45	Seite 46-47	Seite 48-49	Seite 50-51	Seite 52-53





86000
Knirps Acryl Display DIN A3
Knirps Acrylic Display DIN A3



86102
Acryl Display für 1 Stk.
Acrylic Display for 1 pc
9 x 8 x 11 cm



86104
Acryl Display drehbar
Twistable acrylic display



86100091
Acryl Tischdisplay für 9 Stk
Acrylic table display for 9 pcs



86100
Halterung
für offenen Schirm
Display
for open umbrella

Auf Anfrage



86105
Tischdisplay mit Wechselmotiv
Table display
with poster to change
24 x 13 x 20 cm



889997 Knirps shopping bag
(18* x 54 cm)
889998 Knirps shopping bag
(18 x 102,5 cm)



889994
Papiertasche
40 x 30 x 10 cm
Paper Bag,
40 x 30 x 10 cm



88005
Acryl Logo 3D
15,5 x 15,5cm
Acrylic logo 3D
15,5 x 15,5 cm

88006
Acryl Logo 3D
40 x 40cm
Acrylic logo 3D
40 x 40 cm



86000 A
Logo
Logo
24 x 13 x 20 cm



8830505
T.050 Carboflex® Flyer
ca. 13 x 18 cm



889991
Standard
Verpackungsmaterial
für T.010
6 x 6 x 20 cm
Standard packing material
for T.010
6 x 6 x 20 cm



889992
Standard Verpackungsmaterial
für T.100 - T.200
5,5 x 5,5 x 30,5 cm
Standard packing material
for T.100 - T.200
5,5 x 5,5 x 30,5 cm



889996
Standard
Verpackungsmaterial
für T.400
6 x 6 x 36,5 cm
Standard packing material
for T.400
6 x 6 x 36,5 cm



889993
Standard Verpackungsmaterial
für Langschirme
12 x 4,5 x 103 cm
Standard packing material
for Stick umbrellas
12 x 4,5 x 103 cm



864002401



864002402

864002401
Wandlösung mit Fächer
60 x 30 x 230 cm (B/T/H),
ca. 16 kg Leergewicht
ca. 45 Taschenschirme und
864002401
for pocket umbrellas only
60 x 30 x 230 cm (W/D/H),
ca. 16 kg tare
Placement with
approx. 45 pocket umbrellas

864002402
Wandlösung mit Lang- und
Taschenschirmen
60 x 30 x 230 cm (B/T/H),
ca. 16 kg Leergewicht
ca. 28 Taschenschirme und
ca. 12 Langschirme
864002402
for pocket and stick umbrellas
60 x 30 x 230 cm (W/D/H),
ca. 16 kg tare
Placement with
approx. 28 pocket umbrellas
and 12 stick umbrellas



86400140
Mobiler Display inkl. Rollen
46 x 38 x 150 cm (B/T/H),
ca. 16 kg Leergewicht
55 Taschenschirme
8 Stockschirme
Mobile Display, incl. wheels
46 x 38 x 150 cm (W/D/H),
ca. 16 kg tare
56 pocket umbrellas and
10 stick umbrellas



CarboFlex®

Knirps nutzt die CarboFlex® Technologie in speziellen Teilen, die aus Voll-Karbon gearbeitet sind. Diese Technologie macht den Regenschirm extrem flexibel und reduziert zusätzlich sein Gewicht.

CarboFlex®

Knirps uses the CarboFlex® technology in select parts which are fully made of carbon. This technology makes the umbrella extremely flexible and additionally reduces its weight.

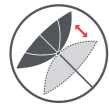

Windproof:

Um eine Beschädigung des Schirms zu vermeiden, klappt das Schirmdach bei ungünstigen Windbedingungen um, ohne dass die Schienen brechen. Knirps Schirme, welche mit diesem Icon gekennzeichnet sind, zeichnen sich durch eine sehr hohe Flexibilität der Schienen aus.

Windproof:

To avoid damage to the umbrella, the canopy folds over during unfavorable weather conditions, without breaking the ribs. Knirps umbrellas, which are marked with this icon, are equipped with highly flexible ribs.

Handhabung Duomatik Schirm:

Einfach die Auslösetaste drücken, den Schirm schließen und erneut öffnen. Das Schirmdach öffnet wie gewohnt und schützt Sie zuverlässig vor Regen.

Handling Duomatic Umbrella:

Push the button, close the umbrella and open it up again. The canopy opens as usual and protects you reliably from rain.

Handhabung Manueller Schirm:

Schirm am Schieber einfach nach unten ziehen und Schirmdach klappt automatisch wieder in die richtige Position zurück und ist wieder bereit für den nächsten Einsatz im Regen.

Handling Manual Umbrella:

Pull the runner downwards and the canopy will automatically fold back into the correct position, leaving the umbrella ready for use during the next rain shower.



Windkanal

Knirps Produkte werden regelmäßig im Windkanal getestet, um ihre Widerstandsfähigkeit zu prüfen.

Wind Tunnel Testing

Knirps products are wind tunnel tested on a regular basis to check their sturdiness.



Hochwertige Komponenten

Diese Modelle sind mit hochwertigen Komponenten ausgestattet:

- Flugzeug-Aluminium, das eine dickere Wandstärke aufweist, leicht, stabil und rostfrei ist
- Spezialbeschichtung, durch die die Stoffe schneller trocknen
- Recycelte Kunststoffe werden vermieden um eine lange Lebensdauer der Produkte zu sichern.

Premium Quality Components

The models are equipped with high quality components:

- Air craft quality aluminum, which has thicker wall strength, is light, robust and stainless.
- Special coating to accelerate the drying of the fabric
- Recycled plastics are avoided to ensure a long service life of the products.



Stahlkomponenten:

Stahlkomponenten machen den Schirm robust, langlebig und extrem windresistent, so dass er nur bei sehr hohen Windgeschwindigkeiten umschlägt.

Steel component:

Steel components make the umbrella robust, durable and extremely wind resistant, only folding over during particularly high wind speeds.



Öko:

Bezugstoff erfüllt Ökotex® 100

Eco:

Canopy fabric complies with Oekotex® Standard 100

MEHR ALS 90 JAHRE Knirps.

Tradition

Die Erfolgsgeschichte der Marke Knirps beginnt im Jahr 1928 mit einer Revolution: der Erfindung des ersten zusammenlegbaren Schirmrahmens. Der Knirps war geboren und die Erfolgsgeschichte nahm ihren Anfang. Möglich wurde der Siegeszug des innovativen Taschenschirms durch die herausragende Qualität der Produkte und die kontinuierliche Weiterentwicklung der Modellpalette mit verschiedenen Größen, Formen und Farben bis hin zu Sonnenschirmen. Die einzigartige Kombination aus Innovation, Design und Qualität hat Knirps über die Jahre in einer Vielzahl von Schirmmodellen umgesetzt und immer weiterentwickelt.

5 Jahre Garantie & Qualität

In jeden Knirps fließen die Erfahrungen aus über 90 Jahren Schirmherstellung ein. Hochwertige Materialien, Liebe zum Detail und konsequente Qualitätskontrolle gehören dabei zur Firmenphilosophie. Daher werden unsere Schirme u. a. in einem Windkanal harten Testverfahren unterzogen, sowie in einem Labor auf Korrosionsbeständigkeit geprüft. Mit dem Erfolg, dass unsere Produkte bei schlechtesten Wetterverhältnissen verwendet werden können und sich durch lange Lebensdauer auszeichnen. Deshalb geben wir auf unser gesamtes Regenschirm Sortiment fünf Jahre Garantie.

Innovation

Der Erfolg der Marke Knirps basiert auf der historischen Innovationskraft, auf die ihre Kunden auch heute noch vertrauen. Daher werden wir auch in Zukunft all unsere Begeisterung, Erfahrung und das über Jahre erworbene Know-how in technisch ambitionierte Produkte investieren, um dieses Vertrauen auch weiterhin rechtfertigen zu können.

Perfektion

Perfektion bedeutet für uns, unseren Kunden ein Produkt zur Verfügung zu stellen, das seinen Nutzen Tag für Tag problemlos unter Beweis stellen kann. Und das gleichzeitig unserem eigenen Anspruch gemäß in Design, Funktion, Material- und Verarbeitungsqualität Maßstäbe setzt. Denn jeder Knirps ist ein Repräsentant der Marke.

Nachhaltigkeit

Durch die Ausführung der Reparaturen durch Fachhändler oder geeignete Reparateure beweist Knirps verantwortungsvolles Handeln der Umwelt gegenüber, weil der Schirm nicht einfach entsorgt und stattdessen ein neues Produkt geliefert wird.

MORE THAN 90 YEARS OF Knirps.

Tradition

The Knirps story started in 1928 with a revolutionary idea: the invention of the first collapsible umbrella frame. Knirps was born and its success story began. The innovative pocket umbrella triumphed due to the outstanding quality of the products and the continuing development of the range of models with different sizes, shapes and colours – as well as garden umbrellas. Knirps has implemented this unique combination of innovation, design and quality into many umbrella models and is still further developing its products.

5 Years Warranty & Quality

Each Knirps is imbued with the experience from over 90 years of umbrella innovation and manufacturing. High-quality materials, attention to detail and strict quality controls are part of our company philosophy. For this reason, our umbrellas undergo rigorous testing procedures, including wind tunnel testing, and are laboratory tested for corrosion resistance. These successful tests demonstrate that our products can be used in the worst weather conditions and maintain a long life. Therefore our complete umbrella assortment carries 5 years warranty.

Innovation

The success of the Knirps brand is based on the historical innovative strength which customers still depend on today. In order to continue to earn this trust, we will continue to invest all of our enthusiasm, experience and engineering expertise in technically ambitious products.

Perfection

For Knirps, perfection means providing our customers with a product that demonstrates its usefulness day after day, in accordance with our high standards in design, function, materials and quality workmanship. After all, every Knirps is a representative of the brand.

Sustainability

Knirps is committed to environmental responsibility by creating quality products that last for many years and by conducting repairs through specialty retailers or repair persons. This ensures that our umbrellas are not simply discarded and replaced by a new product.

GESCHICHTE / HISTORY

1928

Hans Haupt entwickelt den ersten faltbaren Taschenschirm - Anmeldung des Markennamens Knirps am 8. November 1928.
Hans Haupt invents the first pocket umbrella - Registration of the brand name Knirps on 8th of November 1928.

1932

Erster Knirps Damenschirm
First Knirps umbrella for women

1938

Erster Knirps Männerschirm
First Knirps umbrella for men

1951

Fachzeitschrift
„Knirps-Verkäuferin“
Trade magazine
"Knirps-Verkäuferin"

1965

Erster Knirps-Schirm mit
Automatik-Öffnung
First Knirps umbrella with
automatic opening

1968

Einführung des
flachen Schirmetuis
Introduction of
flat umbrella case

1969

Red Dot Warenzeichen und
Red Dot Garantie
Red Dot trademark and
Red Dot warranty

1977

Einführung des Jumbo Knirps
Introduction of Jumbo Knirps

1990

Patentanmeldung für Knirps
Minimatic® und Topmatic®
Patent registration for Knirps
Minimatic® and Topmatic®

1997

Patentregistrierung von Knirps
Duomatic Schirmen -
Automatischer Öffnungs- und
Schließmechanismus
Patent registration for Knirps
Duomatic umbrellas - Automat-
ic open and close mechanism

2003

Knirps X1 – einer der kleinsten
und innovativsten Knirps
Schirme aller Zeiten
Knirps X1 – one of the smallest
and most innovative Knirps
umbrellas of all times

2003

Gründung der Knirps
Licence Corporation –
Internationalisierungsprozess
Founding of the Knirps License
Corporation - Globalisation
process

2004

Design Award Gewinner
X1 und T1 - Innovative Design
Concept
Design Award winner
X1 and T1 – Innovative Design
Concept

2006

Einführung des Bestsellers
878 T2 Duomatic
Introduction of the bestselling
878 T2 Duomatic

2011

Einführung der Knirps
Reisebekleidung
Introduction of Knirps
travel wear

2012

Einführung der Knirps
Sonnenschirme
Introduction of Knirps
garden shades

2016

Neues Design, optimale
Konstruktion: unsere T.SERIES
New design – optimal
construction: our T.SERIES

2018

90 Jahre Knirps
90 Anniversary Knirps

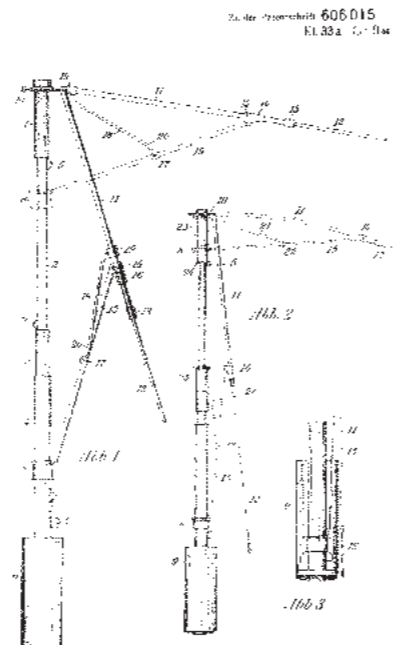

Australia

PORCHLIGHT BRAND
MANAGEMENT
Level 2, 141 York Street
Sydney NSW 2000
Ph: +61 (0)2 9264 5177
stephen@porchlight.com.au

Austria

DOPPLER, E. Doppler & Co GesmbH
Schloßstraße 24
5280 Braunau-Ranshofen
Ph: +43 (0)7722 63205 335
Fax: +43 (0)7722 63205 9335
info@knirps.com

BeNeLux

KNIRPS BENELUX B.V.
P.O. Box 153
4870 AD Etten-Leur
Ph: +31 (0)76 504 1360
Fax: +31 (0)76 504 0943
info@knirps.nl

Canada

HOLIDAY GROUP
4875, boul. Des Grandes Prairies
Montréal, Québec, Canada H1R 1X4
Ph: +1 (0)514 325 0665 403
Fax: +1 (0)514 325 4259
holiday@holiday.ca

China

KNIRPS (XIAMEN)
TRAVELWEARS CO. LTD.
Unit 11, 25F, No2 Building
No 474, XingLinWan Road
Jimei District
361000 Xiamen
Ph: +86 (0)592 628 5446
Fax: +86 (0)592 628 5445
info@knirps.cn

Croatia

MARAS DOO
Vrbik 8a
1000 Zagreb
Ph: +385 (0)1 6198 732
maras@maras.hr

Denmark

SCANDINAVIAN TRAVEL
INNOVATION AB
Björklundbacken 10
436 57 Hovås
Ph: +46 (0)31 749 24 00
Fax: +46 (0)31 749 24 99
info@travelinnovation.se

France

KNIRPS FRANCE S.A.R.L.
2, rue courtois
92320 Chatillon
Ph: +33 (0)1 46 73 92 70
Fax: +33 (0)1 46 73 92 71
knirpsfr@club-internet.fr

Germany

DOPPLER, H. Würflingsdobler GmbH
A. Kolpingstrasse 3
84359 Simbach am Inn
Ph: +49 (0)8571 91 22 335
Fax: +49 (0)8571 91 22 9335
info@knirps.com

Greece

BUTTERCUP HELLAS LTD.
Str. Stadiou 60
Athens, 105 64
Ph: +30 210 3319 821
Fax: +30 210 3219 545
info@buttercuphellas.gr

Italy

GREEN SRL Unipersonale
Via 4 Novembre, 19
22029 Uggiate Trevano (CO)
Ph: + 39 (0)522 160 64 95
info@green-italia.it

Japan

IMAO CORPORATION
2002, Senbiki, Seki
Gifu 501-3954
Ph: +81(0)575 28 5823
Fax: +81(0)575 27 0012
info@imao.jp

Portugal

MALAS PEIXOTO SOARES, LDA.
Rua Carlos D. Caneças, 18-A
2700-163 Amadora
Ph: +351 (0)214 989 740
Fax: +351 (0)214 89 749
info@mps.pt

Russia

RADIUS DESIGN LTD
Fokina Str. 1
194044, St. Petersburg, Russia
Ph 1: +7(812) 424 3425
Ph 2: +7(495) 108 0603
info@knirps-shop.ru

Singapore

GIESSWEIN
INTERNATIONAL TRADING PTE. LTD.
1003 Bukit Merah Central 07-13
Singapore 159836
Ph: +65 (0)872 24490
m.giesswein@giesswein-trading.com

Spain

MARQUÉZ JIMÉNEZ ANTONIO JESUS
Av. Marques de la Vega de Armijo, 17
14550 Córdoba
Ph: +34957650428
info@paraguasdoppler.es

Sweden

SCANDINAVIAN TRAVEL INNOVATION AB
Björklundbacken 10
436 57 Hovås
Ph: +46 (0)31 749 24 00
Fax: +46 (0)31 749 24 99
info@travelinnovation.se

Switzerland

STROTZ AG
Herrenackerstraße 16
8730 Uznach
Ph: +41 (0)55 285 97 00
Fax: +41 (0)55 285 97 09
info@strotz.ch

Taiwan

IUMBRELLA INTERNATIONAL MARKETING CO.,LTD
NO.346, 14th Lin,Xinfeng Village, Xinfeng Township,
Hsinchu County 304 Taiwan
Republic of China (Taiwan)
Ph: +886 3-5515350
Fax: +886 3-55155250
i.umbrella.tw@gmail.com

The Ukraine

MACRO PLUS TRADING LLC
5. Stadionnaya Str.
03680 Kyiv
Ph: +38 0444 952 262
product@macro-plus.com

United Kingdom

PELHAM LEATHER GOODS LIMITED
110, Centennial Avenue, Centennial Park
Elstree, Herts, WD6 3SB
Ph: +44 (0)20 8731 3500
Fax: +44 (0)20 8731 3501
daleludriecus@pelhamgroup.co.uk

USA

COMPASS PARTNERS INTERNATIONAL
246 Fifth Avenue
Suite 513
New York, NY 10001
Ph: +1 (0)212 695 3001
Fax: +1 (0)212 695 3004
info@c-p-intl.com



Knirps

